



**SPACEWALL<sup>®</sup>**  
L a d e n b a u s y s t e m

Warenträger // Accessories



# SPACEWALL®

Ladenbausystem

## SPACEWALL® Warenträger SPACEWALL® Accessories

### Die tragende Rolle im Verkauf

Für verschiedenste Anwendungsbereiche bietet Spacewall® ein umfangreiches Sortiment von Warenträgern aus Metall oder Kunststoff. Die große Auswahl garantiert den optimalen Einsatz von Spacewall® in sämtlichen Branchen des Einzelhandels. Neben der erstklassigen Qualität und Verarbeitung unserer Produkte erreichen wir durch die spezielle Bauweise und Anpassung unserer Warenträger an die Nutprofile eine außergewöhnlich hohe Tragkraft. Profitieren Sie vom „System“ Spacewall durch Einsatz von bestens aufeinander abgestimmten Warenträgern, Abschlussprofilen und Lamellenwänden.

### Sonderanfertigungen

Die in diesem Katalog vorgestellten Warenträger stellen unser Standardprogramm dar, dass nahezu alle Bereiche abdeckt. Für spezielle Einsatzzwecke liefern wir jedoch zusätzlich Warenträger und Zubehör nach Ihren Vorgaben. Unsere Berater stehen Ihnen gern zur Seite.

### Carrying Your business

*For various fields of application, Spacewall® offers a wide range of accessories made of metal or plastic. The great variety guarantees the optimal use of Spacewall® in all retail trade branches. In addition to quality and handling of our products, we achieve a high load capacity of our accessories. Get advantage by using perfectly balanced accessories, profiles and slatwalls.*

### Custom-made Accessories

*The accessories presented herein compose our standard range which covers almost all purposes. For special purposes, we additionally deliver custom-made accessories according to your requirements. We look forward to sharing our expertise with you.*





# SPACEWALL®

Ladenbausystem

## Warenträger & Zubehör

### Accessories

#### Inhalt

<b>SPACEWALL® Warenträger</b> .....	<b>6</b>
<i>SPACEWALL accessories</i>	
Metall-Warenträger / Metal Accessories .....	<b>8</b>
Glas- und Holzbodenträger / Wood and Glas Shelf Brackets ..	8,14
Flachbildschirm-Halter / Flatscreen Holder .....	8
Sonderprogramm Fahrradteile / Special accessories bike .....	9
Einzelhaken / Single Hooks .....	10
Doppelhaken / Double Hooks .....	11
Pendeltaschen / Price Tags Holders .....	11
Diebstahlschutz / Theft Protection .....	11
Abhängearme / Straight and Sloping Arms .....	12
Abhängestangen / U-racks .....	15
Sonstige Warenträger / Miscellaneous Accessories .....	15
Warenträger Seidenmatt / Satin Chromed Accessories .....	20
Spacewall Black Line / Spacewall Black Line .....	21
Warenträger-Sonderprogramm / Special Accessories .....	23
Kunststoff-Warenträger / Plastics Accessories .....	25
Warenträger SLIM / Slim Accessories .....	32
<b>SPACEWALL® Profile &amp; Kleinteile</b> .....	<b>35</b>
<i>SPACEWALL Profiles</i>	
<b>SPACEWALL® Interlink</b> .....	<b>38</b>
<i>SPACEWALL Interlink</i>	
<b>SPACEWALL® Pivot</b> .....	<b>40</b>
<i>SPACEWALL Pivot</i>	
<b>SPACEWALL® Ladenbausysteme</b> .....	<b>42</b>
<i>SPACEWALL Shop Systems</i>	
MONOSTYLE / Monostyle .....	42
MINISTYLE / Ministyle .....	46
MICROSTYLE / Microstyle .....	48
<b>Index nach Artikelnummern</b> .....	<b>54</b>
<i>Index by Item Numbers</i>	



Warenträger direkt online bestellen unter:  
Order accessories directly at:

[www.spacewall-shop.com](http://www.spacewall-shop.com)



**SPACEWALL®**  
Ladenbausystem

**Metall-  
Warenträger**

*Metal  
Accessories*

METALL

■ Glas- und Holzbodenträger / Wood and Glass Shelf Brackets

**Glasplattenträger**  
Glass Shelf Bracket



mit Gummieinlage, für Glasplatten mit 8 mm Stärke und Tiefe bis max. 300 mm  
for glass shelves with 8 mm thickness and max. depth of 300 mm

B (mm)	Plattenstärke / Thickness	Art.-Nr.:
50*	8	MF 265-1
1000	8	MF 265-2
50*	8	<sup>1)</sup> MF 265-7
1000	8	<sup>1)</sup> MF 265-8

**Glasplattenhalter XL**  
Glass Shelf Bracket XL

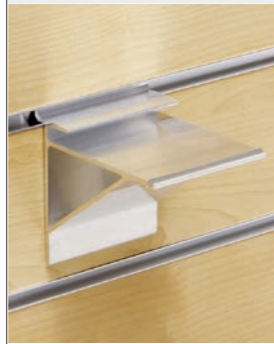

für Glasplatten mit 8 mm Stärke und größerer Glasplattentiefe von 350 bis 400 mm  
for glass shelves with 8 mm thickness and max. depth of 350 to 400 mm

B (mm)	Plattenstärke / Thickness	Art.-Nr.:
75*	8	MF 265-11
1000	8	MF 265-12
75*	8	<sup>1)</sup> MF 265-13
1000	8	<sup>1)</sup> MF 265-14

**Glasplattenträger**  
Glass Shelf Bracket



wie oben, jedoch für Glasplatten mit 10 mm Stärke  
see above, but for glass shelves with 10 mm thickness

B (mm)	Plattenstärke / Thickness	Art.-Nr.:
50*	10	MF 265-3
1000	10	MF 265-4
50*	10	<sup>1)</sup> MF 265-9
1000	10	<sup>1)</sup> MF 265-10

**Holzbodenhalter XL**  
Wood Shelf Bracket XL



für Holzböden mit 19 mm Stärke und max. Tiefe bis 400 mm  
for wood shelves with 19 mm thickness, max. depth up to 400 mm

B (mm)	Plattenstärke / Thickness	Art.-Nr.:
75*	19	MF 265-15
1000	19	MF 265-16

<sup>1)</sup> eloxiert E6 EV1  
/ anodised E6 EV1

■ Flachbildschirm-Halter / Flatscreen Holder

**Universal Plasma-Halter**  
Plasma Flatscreen Holder



für Geräte bis 50 Zoll Bildschirmdiagonale, Lochgröße: 35 mm, Lochabstand 18 mm  
for flatscreens up to 50", size of holes 35 mm, hole spacing 18 mm

L (mm)	Art.-Nr.:
750	MF 278

■ Warenträger-Sonderprogramm Fahrradteile / Special Accessories Bike

**Halter für Fahrradpedale (3-fach)**  
Holder for bicycle-pedals (triple)



schwarz pulverbeschichtet  
black powder coated

T x B x H (mm)	Art.-Nr.:
240 x 8 x 30	MF 280-2

**Halter für Anbauteile**  
Holder for attachment parts



schwarz pulverbeschichtet, mit 400 mm Querrohr zum Anbringen von Scheinwerfern, Fahrradcomputern, KLIICKfix-Produkten  
black powder coated, with crosspipe for fixing lighters, bike computers, KLIICKfix products etc.

T x B x H (mm)	Art.-Nr.:
100 x 400 x 30	MF 281

**Abhängearm (1-kerbig)**  
Straight Arm (single notch)



schwarz pulverbeschichtet, zur Präsentation von Rucksäcken, Kleidungsstücken etc.  
black powder coated, for presenting backpacks, clothing, etc.

T x B x H (mm)	Art.-Nr.:
200 x 6 x 30	MF 282

**Abhängearm (3-kerbig)**  
Straight Arm (triple notch)



schwarz pulverbeschichtet, zur Präsentation von Rucksäcken, Kleidungsstücken etc.  
black powder coated, for presenting backpacks, clothing, etc.

T x B x H (mm)	Art.-Nr.:
350 x 6 x 30	MF 283

**Halter für Fahrradpedale (3-fach)**  
Holder for bicycle-pedals (triple)



schwarz pulverbeschichtet, mit Gewindebuchsen  
black powder coated, with mounting threads

T x B x H (mm)	Art.-Nr.:
240 x 50 x 30	MF 280-1

**Hinweis für alle Warenträger in diesem Katalog**  
Please notice for all accessories in this catalogue

Um die optimale Tragfähigkeit unserer Lamellenwände zu gewährleisten, sollten Spacewall - Warenträger mindestens 10 cm vom Rand der Wand eingesetzt werden.

To ensure the optimum load capacity of our slatwalls, Spacewall accessories should be placed at least 4 inches from the edge of the slatwall.

## Einzelhaken / Single Hooks

**Einzelhaken**  
Single Hook

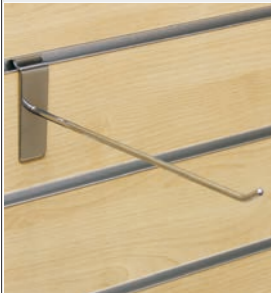

Mit Aufkantung 45°  
with lip 45°

L (mm)	Art.-Nr.:
40	TW 401-6
60	TW 401-7
80	TW 401-8
100	TW 401-1
150	TW 401-2
200	TW 401-3
250	TW 401-4
300	TW 401-5

**Einzelhaken**  
Single Hook

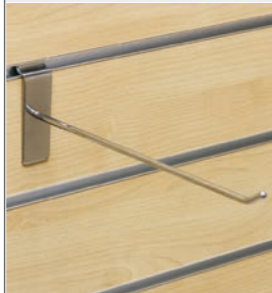

mit Aufkantung 45°  
with lip 45°

L (mm)	Art.-Nr.:
100	TW 4100-1
150	TW 4100-2
200	TW 4100-3
250	TW 4100-4
300	TW 4100-5

**Einzelhaken mit Kappe**  
Single Hook with cap



mit Aufkantung 45°,  
Kappe schwarz  
with lip 45°, black cap

L (mm)	Art.-Nr.:
60	TW 411-1
100	TW 411-2
150	TW 411-3
200	TW 411-4
250	TW 411-5
300	TW 411-6

**Schwerlasthaken**  
Single Hook

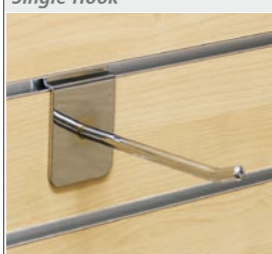

mit Aufkantung  
with lip

L (mm)	Art.-Nr.:
160	TW 464
250	TW 464-4
350	TW 464-6
400	TW 464-7

**Einzelhaken**  
Single Hook



mit Vorrichtung für Pendel-  
tasche TW 476-1 bis 476-3  
(separat zu bestellen)  
with mounting for price tag  
TW 476-1 to 476-3 (order separately)

L (mm)	Art.-Nr.:
150	TW 414-2
200	TW 414-3
250	TW 414-4
300	TW 414-5

**Einzelhaken**  
Single Hook

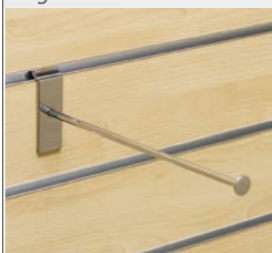

mit 16 mm Scheibe  
with disc 16 mm

L (mm)	Art.-Nr.:
150	TW 477-2
200	TW 477-3
250	TW 477-4
300	TW 477-5

**Einzelhaken**  
Single Hook

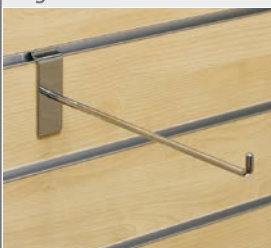

mit Aufkantung 90°  
with lip 90°

L (mm)	Art.-Nr.:
50	TW 473-0
100	TW 473-1
150	TW 473-2
200	TW 473-3
250	TW 473-4

**Einzelhaken**  
Single Hook

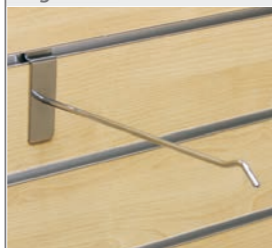

mit Auffangschutz  
with drop-down stop

L (mm)	Art.-Nr.:
100	TW 479-1
150	TW 479-2
200	TW 479-3
250	TW 479-4
300	TW 479-5

## Doppelhaken / Double Hooks

**Doppelhaken**  
Double Hook

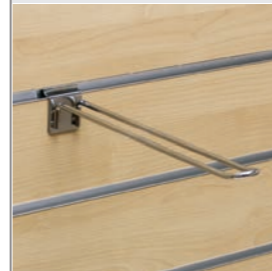

L (mm)	Art.-Nr.:
100	TW 400-1
150	TW 400-2
200	TW 400-3
250	TW 400-4
300	TW 400-5

**Doppelhaken**  
Double Hook



vorne eckig  
angular front

L (mm)	Art.-Nr.:
100	TW 4101-1
150	TW 4101-2
200	TW 4101-3
250	TW 4101-4
300	TW 4101-5

**Doppelhaken**  
Double Hook



mit Vorrichtung für Pendel-  
tasche TW 476-1 bis 476-3  
(separat zu bestellen)  
with mounting for price tag  
TW 476-1 to 476-3 (order separately)

L (mm)	Art.-Nr.:
150	TW 4175-1
200	TW 4175-2
250	TW 4175-3
300	TW 4175-4
350	TW 4175-5

**Doppelhaken**  
Double Hook

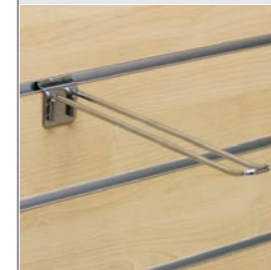

eckig  
angular

L (mm)	Art.-Nr.:
150	TW 478-2
200	TW 478-3
250	TW 478-4

## Pendeltaschen / Price Tags Holders

**Pendeltasche**  
Price Tag Holder



für TW 414 und TW 4175  
for TW 414 and TW 4175

B x H (mm)	Art.-Nr.:
43 x 40	TW 476-1
70 x 40	TW 476-2
100 x 40	TW 476-3

**Pendeltasche**  
Price Tag Holder

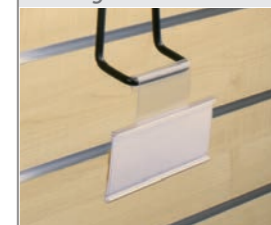

für Helm- / Huthalter  
TW 455-2  
for helmet / hat holder  
TW 455-2

B x H (mm)	Art.-Nr.:
105 x 40	TW 476-5

## Diebstahlschutz / Theft Protection

**Magnet-Warenschloss**  
Magnetic Goods Lock



für Einzel- und Doppel-  
haken bis 6 mm Draht-  
durchmesser. Mit Magnet-Spezial-  
schlüssel einfach zu öffnen.  
for single and double hooks up to  
6 mm wire diameter. Easy to open  
with special magnetic key.

Farbe / colour	Art.-Nr.:
schwarz / black	TW 499-1
rot / red	TW 499-2
weiß / white	TW 499-3

Schlüssel / key	Art.-Nr.:
	TW 499-0

**Diebstahlsicherer Einzelhaken**  
Theft-proof Single Hook



zum Sichern von Ware und  
Einzelhaken, mit Magnet-  
Spezialschlüssel einfach zu öffnen.  
Mit Preisschild-Halter. Kunststoff-  
farbe weiß.  
to secure goods and single hook,  
easy to open with magnetic key.  
With price tag holder. White plastics.

L (mm)	Art.-Nr.:
180	TW 454-1
230	TW 454-2

Schlüssel / key	Art.-Nr.:
	TW 454-0

Abhängearme / Straight and Sloping Arms

Abhängearme / Straight and Sloping Arms

**Abhängearm**  
Sloping Arm



30° vorgeneigt,  
mit 7 Kugeln  
with 7 balls, 30° slant

L (mm)	Rohr / tube (mm)	Art.-Nr.:
400	18 x 18	TW 404

**Abhängearm**  
Sloping Arm



30° vorgeneigt,  
mit 7 Kugeln  
with 7 balls, 30° slant

L (mm)	Rohr / tube (mm)	Art.-Nr.:
400	38 x 13	TW 405

**Abhängearm**  
Bent Arm



vorgeneigt, gebogen  
mit 14 Kugeln  
slant, with 14 balls

L (mm)	Art.-Nr.:
350	TW 452

**Abhängearm**  
Sloping Arm



30° vorgeneigt,  
mit 10 Kerben  
with 10 notches, 30° slant

L (mm)	Art.-Nr.:
410	TW 453

**Abhängearm**  
Sloping Arm

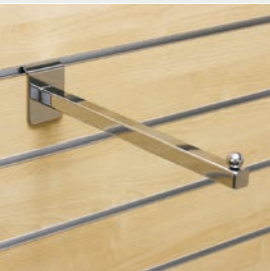

mit Kugel  
with 1 ball

L (mm)	Rohr / tube (mm)	Art.-Nr.:
300	18 x 18	TW 406

**Abhängearm**  
Sloping Arm



30° vorgeneigt,  
mit 6 Stiften  
with 6 pins, 30° slant

L (mm)	ø Ovalrohr / tube (mm)	Art.-Nr.:
260	30 x 15	TW 441-1

**Abhängearm**  
Sloping Arm



15° vorgeneigt  
15° slant

L (mm)	Löcher / holes	Art.-Nr.:
430	12	TW 456-1
245	6	TW 456-2

**Abhängearm**  
Straight Arm

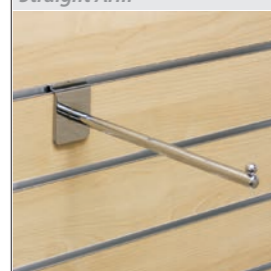

mit Kugel  
with ball

L (mm)	Art.-Nr.:
270	TW 463

**S-Abhängearm**  
S-Arm



mit 2 Kugeln  
with 2 balls

L (mm)	ø Ovalrohr / tube (mm)	Art.-Nr.:
400	30 x 15	TW 442

**Z-Abhängearm**  
Z-Arm

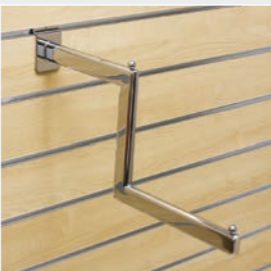

mit 2 Kugeln  
with 2 balls

L (mm)	Art.-Nr.:
395	TW 445

**Abhängearm**  
Sloping Arm

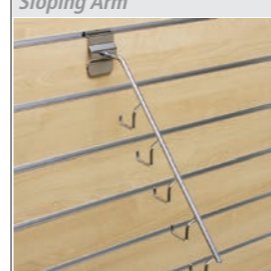

30° vorgeneigt  
30° slant

L (mm)	Haken / hooks	Art.-Nr.:
210	3	TW 469-1
300	5	TW 469-2

**Abhängearm**  
Sloping Arm

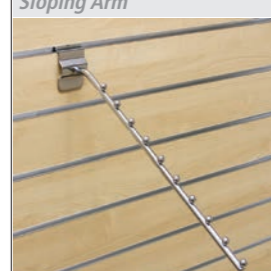

15° vorgeneigt,  
mit 10 Kugeln  
with 10 balls, 15° slant

L (mm)	Art.-Nr.:
385	TW 470

**Abhängearm**  
Sloping Arm



30° vorgeneigt,  
mit 6 Haken  
with 6 hooks, 30° slant

L (mm)	Art.-Nr.:
400	TW 447

**Abhängearm**  
Straight Arm

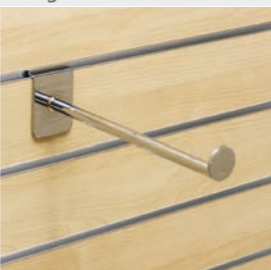

mit Scheibe  
with disc

L (mm)	ø Scheibe / disc (mm)	Art.-Nr.:
250	33	TW 448-1
300	33	TW 448-2

**Abhängearm**  
Display

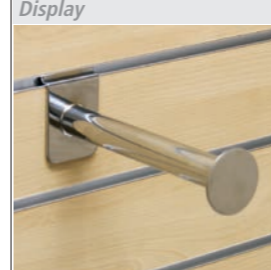

für Ketten, Ringe, Schmuck  
mit 50 mm Scheibe  
for chains, rings, jewellery  
with 50 mm disc

L (mm)	Art.-Nr.:
150	TW 481-1
200	TW 481-2

**Abhängearm**  
Display Arm

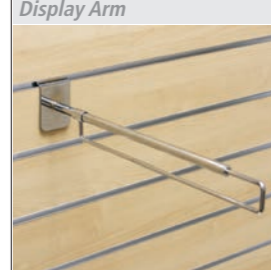

ausziehbar  
telescopic

L (mm)	Art.-Nr.:
340 – 680	TW 483

**Abhängearm**  
Sloping Arm

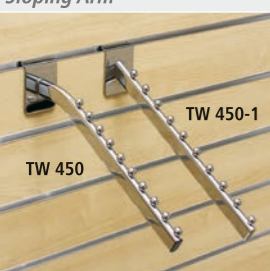

30° vorgeneigt,  
mit 10 Kugeln,  
gebogen (TW 450)  
with 10 balls, 30° slant,  
bent (TW 450)

L (mm)	ø (mm)	Art.-Nr.:
300	25 x 12,5	TW 450
300	25 x 12,5	TW 450-1

**Abhängearm**  
Straight Arm

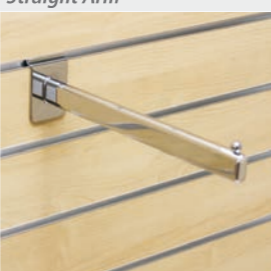

mit Kugel  
with ball

L (mm)	ø Ovalrohr / tube (mm)	Art.-Nr.:
300	30 x 15	TW 451-1
400	30 x 15	TW 451-2

Glas- und Holzbodenträger / Glass and Wood Shelf Brackets

Abhängestangen // sonstige Warenträger / U-racks // others

**Glas- / Holzbodenträger**  
Glass / Wood Shelf Bracket



(Glas-/Holzbodenauflege TW 410-1/-2 müssen sep. bestellt werden)  
(Order Glass / Wood shelf support clips TW 410-1/-2 separatly)

L (mm)	Art.-Nr.:
200	TW 402-1
250	TW 402-2
300	TW 402-3

**Glas- / Holzbodenträger**  
Glass / Wood Shelf Bracket



max. 40° neigbar  
(Glas-/Holzbodenauflege TW 410-1/-2 müssen separat bestellt werden)  
adjustable up to 40°  
(Order Glass / Wood shelf support clips TW 410-1/-2 separatly)

L (mm)	Art.-Nr.:
350	TW 403

**Abhängestange**  
U-Rack



mit Glasplattenhalter, Ovalrohr 25 x 12,5 x 1,5 mm  
with tab end stop, with bores, size of tube 25 x 12,5 x 1,5

L x B (mm)	Art.-Nr.:
300 x 640	TW 407

**Abhängestange**  
U-Rack



L x B 300 x 1040 mm (inkl. Platinen), mit 2 Kugeln, Ovalrohr 25 x 12,5 x 1,5 mm  
300 x 1040 mm (incl. backplates), with 2 balls, size of tube 25 x 12,5 x 1,5 mm

Front	Art.-Nr.:
gerade / straight	TW 407-1
gebogen / bent	TW 418

**Glas- / Holzbodenträger**  
Glass / Wood Shelf Bracket



mit Aufkantung  
with lip

T (mm)	Art.-Nr.:
150	TW 409-0
200	TW 409-1
250	TW 409-2
300	TW 409-3
350	TW 409-4

**Glas- / Holzbodenauflege**  
Shelf Support Clips

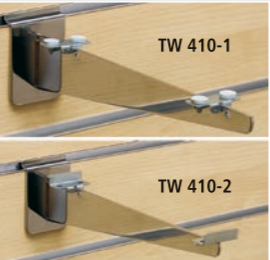

f. Glas- / Holzbodenträger TW 409-1/2/3/4, TW 402-1/2/3 und TW 403  
for glass / wood shelf bracket TW 409-1/2/3/4, TW 402-1/2/3 and TW 403

L x H (mm)	Boden / shelf	Art.-Nr.:
20 x 38	Glas / glass	TW 410-1
25 x 38	Holz / wood	TW 410-2

**Abhängestange**  
U-Rack



ohne Glasplattenhalter, Ovalrohr 25 x 12,5 x 1,5 mm  
without balls or bores  
size of tube 25 x 12,5 x 1,5

L x B (mm)	Art.-Nr.:
300 x 640	TW 407-2

**Konsole mit Abhängestange**  
Shelf with Hanging Tube



mit je 2 Bohrungen, mit Ring, Ovalrohr Konsole 25 x 12 mm, inkl. Abhängestange gerade 600 mm, Ø Rohr 22 mm  
with 2 bores apiece, with ring, shelf tube 25 x 12 mm, incl. hanging tube straight 600 mm, Ø tube 22 mm

L x B (mm)	Art.-Nr.:
300 x 600	TW 407-3

**Glasbodenträger**  
Glass Shelf Bracket



gerade, inkl. Kunststoff-ringe  
straight, incl. plastic rings

L (mm)	Art.-Nr.:
150	TW 424-0
200	TW 424-1
250	TW 424-2
300	TW 424-3
350	TW 424-4

**Regalkonsole**  
Shelf Bracket



für Glas- u. Holzböden, paarweise  
for glass and wood shelves, by pairs

L (mm)	Farbe / colour	Art.-Nr.:
230	weiß / white	TW 430-3
330	weiß / white	TW 430-4
280	weiß / white	TW 430-5

**Abhängestange**  
U-Rack



ohne Glasplattenhalter, Ovalrohr 25 x 12,5 x 1,5 mm  
without balls or bores  
size of tube 25 x 12,5 x 1,5

L x B (mm)	Art.-Nr.:
300 x 640	TW 407-2

**Stützzange**  
Upright Bracket

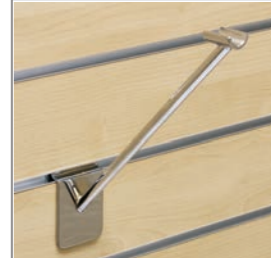

für TW 407 / 407-1 / 407-2 / 418 bei Lamellenabstand 101,8 mm  
for TW 407 / 407-1 / 407-2 / 418 for slatwidth 101,8 mm,

L (mm)	Art.-Nr.:
278	TW 417

**Glas- / Holzbodenträger**  
Glass / Wood Shelf Bracket

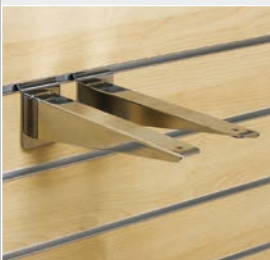

gerade, paarweise  
straight, by pairs

L (mm)	Art.-Nr.:
200	TW 443-0
250	TW 443
300	TW 443-1
350	TW 444

**Glas- / Holzbodenträger**  
Glass / Wood Shelf Bracket

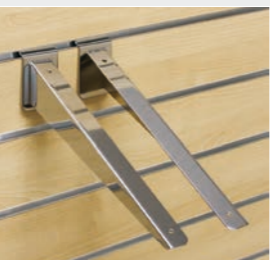

30° vorgeneigt, paarweise  
30° slant, by pairs

L (mm)	Art.-Nr.:
300	TW 443-5

**Abhängestange**  
U-Rack

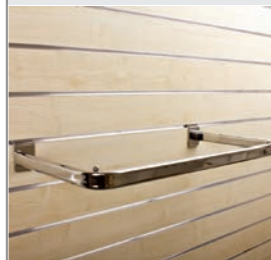

Mit 2 Kugeln, Ovalrohr 25 x 15 mm, Platinen außen bündig  
with 2 balls, oval tube 25 x 15 mm, backplates aligned with tube

L x B (mm)	Art.-Nr.:
330 x 300	TW 407-6
330 x 600	TW 407-7
330 x 1000	TW 407-8

**Regalrückplatte**  
Backplate Support



mit 2 Bohrungen  
with 2 bores

LxB (mm)	Farbe / colour	Art.-Nr.:
51 x 69	grau / grey*	TW 408
52 x 70	chrom / chrome	TW 474

**Regalkonsole**  
Shelf Bracket

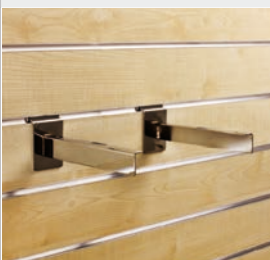

für Glas- u. Holzböden, paarweise  
for glass and wood shelves, by pairs

L (mm)	Art.-Nr.:
200	TW 4443-0
250	TW 4443-1
300	TW 4443-2
350	TW 4443-3

**Glas- / Holzbodenträger**  
Glass / Wood Shelf Bracket

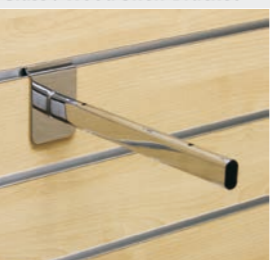

gerade, mit Bohrungen  
straight, with bores

L (mm)	ø (mm)	Art.-Nr.:
150	25 x 12,5	TW 472-0
200	25 x 12,5	TW 472-1
250	25 x 12,5	TW 472-2
300	25 x 12,5	TW 472-3
350	25 x 12,5	TW 472-4
400	25 x 12,5	TW 472-5

**Konsole**  
Hidden Shelf



mit 4 Bohrungen  
with 4 holes

L x B (mm)	Art.-Nr.:
42 x 48 mm	TW 413

**Regal**  
Wire Basket



für CDs, DVDs, Bücher etc.  
for CDs, DVDs, books etc.

L x B x H (mm)	Art.-Nr.:
530 x 180 x 180	TW 416



Sonstige Warenträger / Miscellaneous Accessories

Sonstige Warenträger / Miscellaneous Accessories

**Buchhalter Metall**  
Metal Book Holder



silber, für Bücher bis 225 mm Höhe  
silver, for books up to 225 mm height

H x B x T (mm)	Art.-Nr.:
170 x 100 x 140	TW 422

**Sohlenzeiger**  
Sole Display

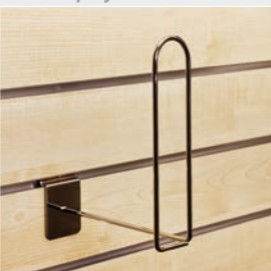

L x H (mm) Art.-Nr.:

200 x 200	TW 423
-----------	--------

**Helm- / Huthalter**  
Helmet / Hat Holder



schwarz, mit Vorrichtung für Preisschildhalter TW 476-5 (separat zu bestellen)  
black, with mounting for price tag TW 476-5 (order separately)

L x B x H (mm)	Art.-Nr.:
280 x 65 x 150	TW 455-2

**Wareschütte**  
Wire Basket



TW 458: vorgeneigt  
TW 459: gerade  
TW 458: slant  
TW 459: straight

L x B x H (mm)	Art.-Nr.:
610 x 305 x 75	TW 458
570 x 300 x 85	TW 459

**Helmhalter**  
Helmet Holder



1 Stütze / support  
2 Ring / ring

L (mm)	Ø Ring / ring (mm)	Art.-Nr.:
250	150	TW 425

**Halter für Basecaps**  
Baseball Cap Holder



Länge der Form: 195 mm  
Length of form: 195 mm

L (mm)	Art.-Nr.:
290	TW 426

**Warenkorb**  
Wire Basket

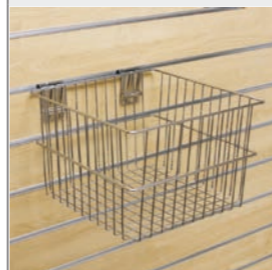

L x B x H (mm)	Art.-Nr.:
300 x 150 x 150	TW 460-1
300 x 300 x 200	TW 460-2

**Regal**  
Wire Shelf



L x B 600 x 300 mm  
size 600 x 300 mm

Neigung / slant	Art.-Nr.:
30° mit Aufkantung / 30° with lip	TW 461-1
gerade mit Aufkantung / straight with lip	TW 461-2

**Schirmmützen-Präsentier**  
Peaked Cap Holder



H x B x T (mm)	Art.-Nr.:
175 x 90 x 160	TW 427

**Konsole**  
Shelf



silber, mit 40 mm Abkantung  
silver, with 40 mm lip

L x B (mm)	Art.-Nr.:
100 x 250	TW 428

**Bilderhaken**  
Picture Hook



L x B (mm)	Art.-Nr.:
14 x 26	TW 462-1
14 x 52	TW 462-2

**Haken**  
Hook

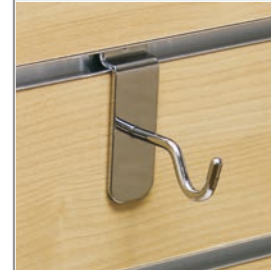

L (mm)	Art.-Nr.:
55	TW 465

**Uhrenhaken**  
Clock Hook

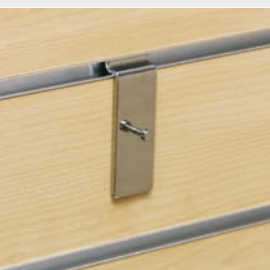

L (mm)	Art.-Nr.:
10	TW 438

**Universalhaken**  
Multi-purpose Hook

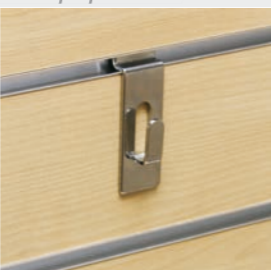

L x B (mm)	Art.-Nr.:
12 x 26	TW 439

**Drehkranz**  
Jewellery Star

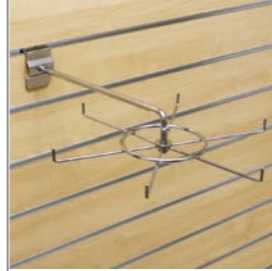

L (mm)	Art.-Nr.:
460	TW 471

**Kleiderbügel**  
Display Hanger

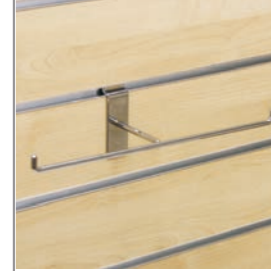

L (mm)	Art.-Nr.:
295	TW 480

**Ringhalterung**  
Ball Display

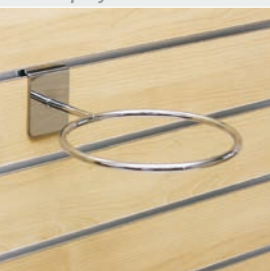

L (mm)	Ø (mm)	Art.-Nr.:
245	145	TW 449
245	110	TW 449-2
245	160*	TW 449-3

\* eloxiert / anodized

**Helm- / Huthalter**  
Helmet / Hat Holder

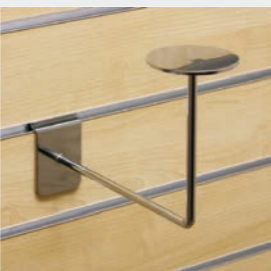

mit Scheibe  
with disc

L (mm)	Ø Scheibe / disc (mm)	Art.-Nr.:
200	78	TW 455

**Frontalbügel**  
Cravat Holder



L (mm)	Art.-Nr.:
600	TW 482

**Kleiderbügel**  
Display Hanger

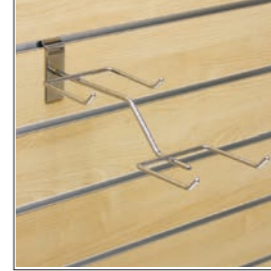

für Gürtel  
for belts

L (mm)	Art.-Nr.:
300	TW 484

## Sonstige Warenträger / Miscellaneous Accessories

### Prospekthalter Metall DinA4

Leaflet Holder



Chrom, für Prospekte bis DinA4  
chrome, for leaflets up to DinA4

H x B x T (mm) Art.-Nr.:  
240 x 225 x 55 TW 415-1



### Prospekthalter Metall DinA5

Leaflet Holder



Chrom, für Prospekte bis DinA5  
chrome, for leaflets up to DinA5

H x B x T (mm) Art.-Nr.:  
160 x 160 x 55 TW 415-2

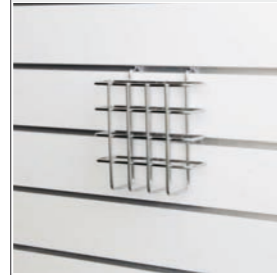

### Halter für Inline-Skates

Holder for inline skates



schwarz,  
für ein Paar / black, for one pair

L x B (mm) Art.-Nr.:  
268 x 200 TW 680-2



### Halter für Inline-Skates

Holder for inline skates



schwarz,  
Für zwei Paar / black, for one pair

L x B (mm) Art.-Nr.:  
490 x 200 TW 680-1



Warenträger Seidenmatt / Satin Chromed Accessories

**Doppelhaken**  
Double Hook



5 mm 48 35

L (mm)	Art.-Nr.:
100	TW 500-1
150	TW 500-2
200	TW 500-3
250	TW 500-4

**Einzelhaken**  
Single Hook



Mit Aufkantung 45°  
with lip 45°

5 mm 75 24

L (mm)	Art.-Nr.:
100	TW 501-1
150	TW 501-2
200	TW 501-3
250	TW 501-4

**Abhängearm**  
Sloping Arm



30° vorgeneigt,  
mit 7 Kugeln  
with 7 balls, 30° slant

75 48

L (mm)	Rohr / tube (mm)	Art.-Nr.:
400	18 x 18	TW 504

**Abhängearm**  
Straight Arm



gerade, mit Kugel  
with 1 ball

75 48

L (mm)	Rohr / tube (mm)	Art.-Nr.:
300	18 x 18	TW 506

**Abhängestange**  
U-Rack



Ovalrohr 25 x 12,5 mm,  
außen geschweißt,  
mit 2 Kugeln  
oval tube 25 x 12,5 mm,  
outward welded, with 2 balls

75 48

L x B (mm)	Art.-Nr.:
300 x 600	TW 507-2

**Glas- / Holzbodenkonsole**  
Glass / Wood Shelf Bracket



gerade, paarweise  
straight, by pairs

75 48

L (mm)	Art.-Nr.:
250	TW 543
300	TW 543-1

**Abhängearm**  
Straight Arm



mit Scheibe  
with disc

12,7 mm 75 48

L (mm)	ø Scheibe / disc (mm)	Art.-Nr.:
300	33	TW 548-2

**Abhängearm**  
Sloping Arm



30° vorgeneigt,  
mit 10 Kugeln  
with 10 balls, 30° slant

75 48

L (mm)	ø (mm)	Art.-Nr.:
300	25 x 12,5	TW 550-1

**Abhängearm**  
Straight Arm



gerade, mit Kugel  
with ball

75 48

L (mm)	ø Ovalrohr / tube (mm)	Art.-Nr.:
300	30 x 15	TW 551-1

**Einzelhaken**  
Single Hook

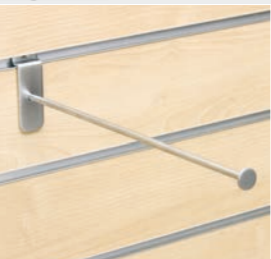

mit 16 mm Scheibe  
with disc 16 mm

6 mm 75 24

L (mm)	Art.-Nr.:
300	TW 577-5

**Einzelhaken**  
Single Hook



Mit Aufkantung 45°  
with lip 45°

L (mm)	Art.-Nr.:
100	TW 6100-1
150	TW 6100-2
200	TW 6100-3
250	TW 6100-4
300	TW 6100-5

**Doppelhaken**  
Double Hook



L (mm)	Art.-Nr.:
100	TW 6101-1
150	TW 6101-2
200	TW 6101-3
250	TW 6101-4
300	TW 6101-5

**Abhängearm**  
Sloping Arm



30° vorgeneigt,  
mit 10 Kugeln  
with 10 balls, 30° slant

L (mm)	ø (mm)	Art.-Nr.:
300	25 x 12,5	TW 650-1

**Einzelhaken**  
Single Hook



mit 16 mm Scheibe  
with disc 16 mm

L (mm)	Art.-Nr.:
300	TW 677-5

**Glas- / Holzbodenkonsole**  
Glass / Wood Shelf Bracket



gerade, paarweise  
straight, by pairs

L (mm)	Art.-Nr.:
250	TW 643
300	TW 643-1

**Abhängearm**  
Straight Arm



mit Scheibe  
with disc

L (mm)	ø Scheibe / disc (mm)	Art.-Nr.:
300	33	TW 648-2

**Abhängearm**  
Straight Arm



gerade, mit Kugel  
with ball

L (mm)	ø Ovalrohr / tube (mm)	Art.-Nr.:
300	30 x 15	TW 651-1

**Abhängestange**  
U-Rack



Ovalrohr 25 x 12,5 mm,  
außen geschweißt,  
mit 2 Kugeln  
oval tube 25 x 12,5 mm,  
outward welded, with 2 balls

L x B (mm)	Art.-Nr.:
300 x 600	TW 607-2 WS/WH

**Abhängearm**  
Sloping Arm



30° vorgeneigt,  
mit 7 Kugeln  
with 7 balls, 30° slant

L (mm)	Rohr / tube (mm)	Art.-Nr.:
400	18 x 18	TW 604

**Abhängearm**  
Straight Arm



gerade, mit Kugel  
with 1 ball

L (mm)	Rohr / tube (mm)	Art.-Nr.:
300	18 x 18	TW 606



SONDERPROGRAMM G

Sonderprogramm G  
Special Accessories G

**Doppelhaken**  
Double Hook



Packungsinhalt: 25 Stück  
25 pieces packing

L (mm)	Art.-Nr.:
120	G 101
200	G 102
250	G 103



**Einzelhaken**  
Single Hook

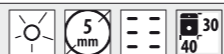

Packungsinhalt: 25 Stück  
25 pieces packing

L (mm)	Art.-Nr.:
120	G 104
200	G 105
250	G 106



**Doppelhaken**  
Double Hook



Packungsinhalt: 25 Stück  
25 pieces packing

L (mm)	Art.-Nr.:
120	G 107
200	G 108
250	G 109



**Einzelhaken**  
Single Hook



Packungsinhalt: 25 Stück  
25 pieces packing

L (mm)	Art.-Nr.:
120	G 110
200	G 111
250	G 112



**Kurzer Abhängehaken**  
Short Hook

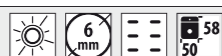

Packungsinhalt: 25 Stück  
25 pieces packing

L (mm)	Art.-Nr.:
45	G 113



# SPACEWALL®



Ladenbausystem



KUNSTSTOFF

**Kunststoff - Warenträger**  
Plastics Accessories

**Konsole**  
Shelf

für Schuh- u. Hartwaren  
*for shoes and homewares*

T x B (mm)	Art.-Nr.:
155 x 300	PF 101-0
100 x 250	PF 101-1
250 x 300 mit Stützen	PF 101-2 *
102 x 202	PF 101-4
155 x 255	PF 101-5
100 x 250 Styren / styrene	PF 101-6

\* handgefertigt / handmade



**Schuhregal**  
Shoe Shelf



25° vorgeneigt,  
mit Spitzenstütze  
*25° slant, with toe stop*

T x B (mm)	Art.-Nr.:
290 x 100	PF 102
290 x 200	PF 103

**Prospekthalter A4 / A5**  
Leaflet Holder A4 / A5

für Karten, Bücher,  
Zeitschriften etc.  
*for cards, books, journals etc.*

T x B x H (mm)	Art.-Nr.:
40 x 160 x 220 (DIN A5)	PF 117-0
40 x 220 x 225 (DIN A4)	PF 117-1

**Prospekthalter A4 / DIN lang**  
Leaflet Holder A4 / DIN lang



für Karten, Bücher,  
Zeitschriften etc.  
*for cards, books, journals etc.*

T x B x H (mm)	Art.-Nr.:
65 x 225 x 225 (DIN A4)	PF 117-2
20 x 110 x 200 (DIN lang)	PF 117-3



**Schuhregal**  
Shoe Shelf



25° vorgeneigt,  
mit 5 mm Absatzstütze  
*25° slant, with 5 mm heel stop*

T x B (mm)	Art.-Nr.:
285 x 200	PF 105

**Schuhregal**  
Shoe Shelf





35° vorgeneigt, mit Spitzen-  
stütze, Materialstärke  
Einhängung 6 mm  
*35° slant, with toe stop, material  
thickness of suspension 6 mm*

T x B (mm)	Art.-Nr.:
100 x 300	PF 106
100 x 300	PF 107

linksseitig / left  
rechtsseitig / right



**Prospekthalter A4**  
Leaflet Holder A4

mit Phototasche  
*with photo pocket*



T x B x H (mm)	Art.-Nr.:
85 x 220 x 305	PF 118

**Preisschildhalter**  
Price Tag Holder

B x H (mm)	Art.-Nr.:
100 x 55	PF 120-1



**Regal**  
Shelf

mit 2 cm Aufkantung  
*with 2 cm lip*

T x B (mm)	Art.-Nr.:
110 x 250	PF 110
200 x 250	PF 111



**Schaukasten**  
Display

für Hemden, Blusen,  
T-Shirts, Pullover, Strick-  
waren etc.  
*for shirts, blouses, T-shirts, sweaters,  
knitwear etc.*

T x B x H (mm)	Art.-Nr.:
305 x 278 x 270	PF 112-1

**Konsole**  
Shelf





mit Einschub für Produkt-  
bzw. Preisinformationen,  
für Schuhe, Hartwaren etc.  
*with price tag holder, for shoes,  
homewares etc.*

T x B (mm)	Einschub- höhe(mm)*	Art.-Nr.:
100 x 203	30	PF 121-0
100 x 250	50	PF 121-1
100 x 230	30	PF 121-2
100 x 229	32	PF 121-4
100 x 250	38	PF 121-5

\* size of price holder



**Schuhhalter**  
Shoe Swivel Bracket

drehbar, mit Spitzenstütze  
*swivel-mounted,  
with toe tip*



T x B (mm)	Art.-Nr.:
230 x 70	PF 122

**Schauregal**  
Shelf

T x B (mm)	Art.-Nr.:
5 mm Aufkantung / 5 mm lip	PF 113-1
280 x 400	PF 113-2
ohne Aufkantung / without lip	PF 113-3
240 x 400	PF 113-3
7,5 mm Aufkantung, Styren 7,5 mm lip, styrene	PF 113-3
270 x 400	PF 113-3

**Schaukasten**  
Display

für Handschuhe, Schals,  
Kleinartikel, etc.  
*for gloves, scarfs, small items etc.*

T x B x H (mm)	Art.-Nr.:
150 x 300 x 35	PF 114-1
150 x 150 x 35	PF 114-2



**Schaukasten**  
Angled Display

vorgeneigt, für Prospekte,  
Schuhe, Zeitschriften etc.  
*slanted, for brochures, shoes,  
journals etc.*

T x B (mm)	Art.-Nr.:
350 x 230 (DIN A4)	PF 124

**Trennkreuz**  
Separating Cross

T x B (mm)	Art.-Nr.:
für PF 114-1 / for PF 114-1	PF 114-3
150 x 300 x 35	PF 114-3
für PF 114-2 / for PF 114-2	PF 114-4
150 x 150 x 35	PF 114-4



**Grußkartenrinne**  
Card Rack



ohne Seitenabschluß,  
auch für DVDS, Bücher, etc.,  
mit Aufkantung 45 mm,  
Neigung ca. 30°  
*without side parts, with 45 mm lip,  
slant ca. 30°*



T x B (mm)	Art.-Nr.:
55 x 600	PF 115

**Haken**  
Hook

B x H (mm)	Art.-Nr.:
25 x 60	PF 141

**Kartenhalter**  
Holder for Posters

für Plakate, Karten,  
Poster etc.  
*for bills, cards, posters etc.*

B x H (mm)	Art.-Nr.:
25 x 70	PF 142

**Display**  
Display



30° vorgeneigt  
für Bücher, Prospekte, etc.  
30° slant, for books, brochures etc.

T x B x H (mm)	Aufkantung / lip (mm)	Art.-Nr.
310x220x60	100	PF 145

**Buchhalter**  
Angled Book Holder

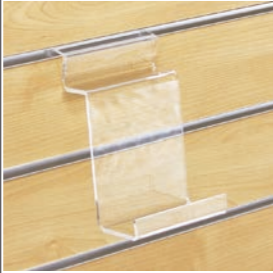

vorgeneigt  
slant

T x B x H (mm)	Aufkantung / lip (mm)	Art.-Nr.
155x100x100	15	PF 146

**Universalköcher**  
Quiver



mit 11 Röhren,  
für Pinsel, Stifte etc.  
with 11 tubes, for brushes, pencils etc.

T x B (mm)	Art.-Nr.
155 x 205	PF 167

**CD-Halter**  
CD-Display



B (mm)	Art.-Nr.
150 (5 CDs)	PF 168-1
295 (10 CDs)	PF 168-2

**Hemdenpräsentier**  
Shirt Display



40° vorgeneigt  
40° slant

T x B (mm)	Art.-Nr.
300 x 200	PF 149

**Damenbein**  
Ladies Leg



gestreckt,  
inkl. Ring-Halterung  
straight, incl. holder ring

L (mm)	Art.-Nr.
700	PF 155

**Bilderrahmenhalter**  
Picture Frame Holder



T (mm)	Art.-Nr.
290 Links / left	PF 176-2
290 Rechts / right	PF 176-3

**Brillenhalter**  
Glasses Holder



für eine offene Präsentation  
for opened presentation

L (mm)	Art.-Nr.
165	PF 181-1

**Warenkasten**  
Box



vorne geschlossen,  
ideal für Feinstrümpfe,  
Taschentücher etc.  
closed front, ideal for stockings,  
handkerchiefs etc.

T x B x H (mm)	Art.-Nr.
178 x 190 x 245	PF 157

**Präsentier**  
Display



T x B x H (mm)	Art.-Nr.
255 x 305 x 150	PF 158

**Brillenhalter**  
Glasses Holder



für eine geschlossene  
Präsentation  
for closed presentation

L (mm)	Art.-Nr.
45	PF 181-2

**Armbanduhrenhalter**  
Holder for Watches



T x H (mm)	Art.-Nr.
50 x 80	PF 184

**Universalmulde**  
Multi-purpose Display



für Bücher, Zeitschriften,  
DVDs, Postkarten, etc.  
for books, journals, DVDs, cards etc.

T x B x H (mm)	Aufkantung / lip (mm)	Art.-Nr.
88x220x130	80	PF 159

**Einzelhaken**  
Single Hook



L (mm) Farbe / colour	Art.-Nr.
100 schwarz / black	PF 161-1
100 weiß / white	PF 161-2
100 grau / grey	PF 161-3
100 farblos / transparent	PF 161-4

**Display**  
Display

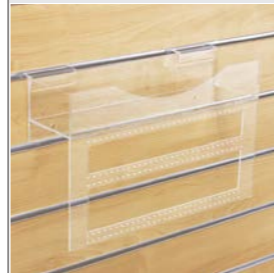

Halterung für Ohringe und  
Schmuck  
Holder for earrings and jewellery

T x B x H (mm)	Art.-Nr.
260x600x300	PF 185

**Display**  
Display



Präsentier für Kleinteile  
Display for small items

T x B x H (mm)	Art.-Nr.
100 x 350 x 130	PF 186

**Einzelhaken**  
Single Hook



L (mm) Farbe / colour	Art.-Nr.
150 schwarz / black	PF 162-1
150 weiß / white	PF 162-2
150 grau / grey	PF 162-3
150 farblos / transparent	PF 162-4

**Universalhaken**  
Multi-purpose Hook



vielseitig einsetzbar, mit  
festem Sitz in der Schiene  
snug fit in slat

B x H (mm)	Art.-Nr.
20 x 21	PF 166

**Schmuckpräsentier**  
Jewellery Display



Halterung für Uhren und  
Armreifen, eine Röhre  
Holder for watches, one tube

T x B (mm)	Art.-Nr.
100 x 335	PF 195

**Schmuckpräsentier**  
Jewellery Display



Halterung für Uhren und  
Armreifen, zwei Röhren  
Holder for watches, two tubes

T x B (mm)	Art.-Nr.
100 x 340	PF 196

**Schmuckpräsentier**  
Jewellery Display



Halterung für Fingerringe  
Holder for rings

T x B (mm)	Art.-Nr.:
100 x 350	PF 197

**Schmuckpräsentier**  
Jewellery Display



Präsentier für Halsketten  
Holder for Necklaces

T x B (mm)	Art.-Nr.:
100 x 350	PF 198

**iPad-Halter**  
iPad Holder



für die iPad-Modelle 2 und 3  
(sowie vergleichbare Tablets  
bis 250 x 186 x 15 mm)  
for iPad models 2 and 3  
(resp. similar tablets up to  
250 x 186 x 15 mm)

T x B x H (mm)	Art.-Nr.:
84 x 194 x 258	TW 489-2

**Schaukasten**  
Display



L x H x B (mm)	Art.-Nr.:
100 x 290 x 50	TW 491

**Präsentier für Zeitschriften**  
Holder for Newspapers



vorgeneigt,  
mit Aufkantung 30 mm  
slant, with 30 mm lip

T x B (mm)	Art.-Nr.:
260 x 600	PF 199

**Präsentier für Zeitschriften**  
Holder for Newspapers



mit Aufkantung 80 mm  
with 80 mm lip

T x B (mm)	Art.-Nr.:
70 x 600 x 200	PF 200

**Prospekthalter DIN A4**  
Leaflet Holder DIN A4



T x B x H (mm)	Art.-Nr.:
43 x 224 x 233,5	TW 493

**Preisschildhalter**  
Price Tag Holder



B x H (mm)	Art.-Nr.:
100 x 50	TW 494

**Prospekthalter**  
Leaflet Holder



für Format DIN A4 / A5  
for DIN A4 / A5 leaflets

T x B x H (mm)	Art.-Nr.:
40 x 165 x 155 (DIN A5) 40 x 220 x 270 (DIN A4)	TW 485-1 TW 485-2

**Plakathalter**  
Poster Holder



für Format DIN A4  
for DIN A4 leaflets

L x B (mm)	Art.-Nr.:
216 x 320	TW 486

**Buchhalter**  
Book Display



vorgeneigt  
slanted

T x B x H (mm)	Art.-Nr.:
90 x 100 x 124	TW 495

**Prospekthalter DIN A4**  
Leaflet Holder DIN A4



T x B x H (mm)	Art.-Nr.:
67 x 226 x 268	TW 496

**Display**  
Display



30° vorgeneigt,  
mit Aufkantung  
30° slant, with front lip

L x B x H (mm)	Art.-Nr.:
285 x 220 x 33	TW 487

**Konsole**  
Shelf



Mit Einschub für Preis-  
bzw. Produktinformation  
(Einschubhöhe 42 mm)  
with sign holder (height 42 mm)

L x B x H (mm)	Art.-Nr.:
100 x 250 x 44 105 x 300 x 44	TW 488 TW 488-1

**Konsole**  
Shelf

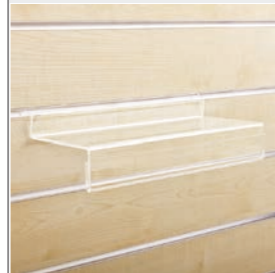

T x B x H (mm)	Thickn. (mm)	Art.-Nr.:
115 x 250 x 50 115 x 290 x 50	2,5 3	TW 497-1 TW 497-2

**Konsole**  
Shelf

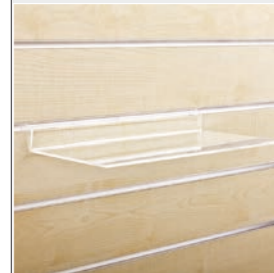

T x B (mm)	Thickn. (mm)	Art.-Nr.:
155 x 300 115 x 250	3 2,5	TW 498-1 TW 498-2

**Smartphone-Halter**  
Smart Phone Holder



für nahezu alle aktuellen  
Smartphone-Modelle bis  
67 mm Breite und 20 mm Tiefe  
for almost all current smart phone  
models up to 67 mm width and 20  
mm thickness.

T x B x H (mm)	Art.-Nr.:
73 x 73 x 124	TW 489-1

**Smartphone-Halter XL**  
Smart Phone Holder XL



für nahezu alle aktuellen  
Smartphone-Modelle bis  
88 mm Breite und 20 mm Tiefe  
for almost all current smart phone  
models up to 88 mm width and 20  
mm thickness.

T x B x H (mm)	Art.-Nr.:
90 x 80 x 160	TW 489-3

**Acryldisplay**  
Display



B x H 230 x 289 mm  
size 230 x 289 mm

Öffnung / opening	Art.-Nr.:
rechts / right links / left	TW 191 R TW 191 L

**Golfschläger-Halterung (2-teilig)**  
Golf Club Holder (2 pieces)



Für 13 Schläger, abgewinkelt  
2-teilig (oben und unten)  
For 13 golf clubs, angled,  
two pieces (top & bottom)

Art.-Nr.:
PF 165-1





## Warenträger SLIM

*Slim Accessories*

**Glasplattenträger**  
Glass Shelf Bracket



für 8 mm Glasböden  
for 8 mm glass shelves

B (mm)	Art.-Nr.:
50	SF 714-1
1000	SF 714-2

auf Anfrage auch eloxiert lieferbar  
/ anodized on request

**Doppelhaken**  
Double Hook

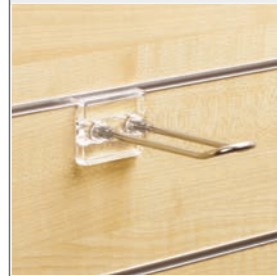

L (mm)	Art.-Nr.:
100	SF 715-1
150	SF 715-2
200	SF 715-3
250	SF 715-4

**Einzelhaken**  
Single Hook

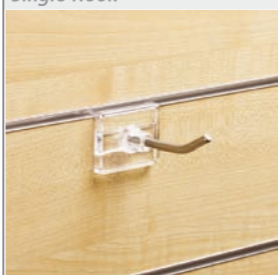

L (mm)	Art.-Nr.:
60	SF 716-1
100	SF 716-2
150	SF 716-3
200	SF 716-4
250	SF 716-5

**Abhängearm**  
Straight Arm

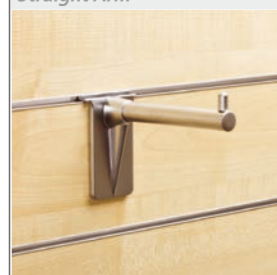

mit 12 mm hohem Stift  
with 12 mm pin

L (mm)	Pin Ø	Art.-Nr.:
100	7 mm	SF 720-1
230	7 mm	SF 720-2
350	7 mm	SF 720-3

**Halter für Abhängestange**  
Bracket for Hanging Tube

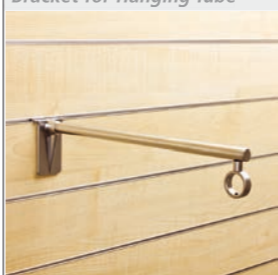

mit Ring für Abhängestange  
SF 722-1 oder -2  
with bearing for hanging tube  
SF 722-1 or -2

L (mm)	Art.-Nr.:
300	SF 721

**Abhängestange**  
Hanging Tube

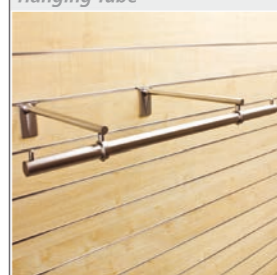

für Halter SF 721  
for bracket SF 721

L (mm)	Pin Ø	Art.-Nr.:
620	7 mm	SF 722-1
1000	7 mm	SF 722-2

**Regalrückplatte**  
Back Plate Support



mit vier Bohrungen  
with 4 holes

L x B (mm)	Art.-Nr.:
66 x 48	SF 723

**Abhängearm**  
Sloping Arm

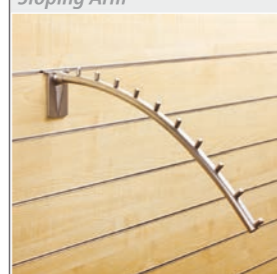

mit 10 Stiften (Abstand 35 mm)  
with 10 pins (interval 35 mm)

L (mm)	Pin Ø	Art.-Nr.:
390	7 mm	SF 726

**Glas- / Holzbodenträger**  
Glass / Wood Shelf bracket



mit 2 Bohrungen  
with 2 holes

L (mm)	Art.-Nr.:
200	SF 730-1
300	SF 730-2

**Abhängearm**  
Sloping Arm

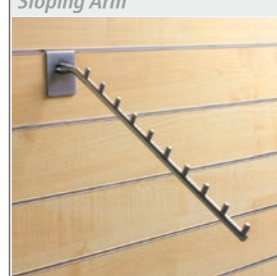

mit 10 Stiften  
with 10 pins

L (mm)	Art.-Nr.:
350	SF 731

**Abhängearm**  
Straight Arm



gerade, mit Stift  
with pin

L (mm)	Pin Ø	Art.-Nr.:
100	7 mm	SF 732-1
150	7 mm	SF 732-2
200	7 mm	SF 732-3
250	7 mm	SF 732-4

**Doppelhaken**  
Double Hook



gerade, mit Stift  
with pin

L (mm)	Art.-Nr.:
100	SF 733-1
150	SF 733-2
200	SF 733-3
250	SF 733-4

**Abhängearm**  
Straight Arm



mit Aufkantung 20°  
with lip 20°

L (mm)	Art.-Nr.:
100	SF 734-1
150	SF 734-2
200	SF 734-3
250	SF 734-4

**Prospekthalter**  
Leaflet Holder



40 x 165 x 155 (DIN A5)  
40 x 220 x 270 (DIN A4)

T x B x H (mm)	Art.-Nr.:
40 x 165 x 155 (DIN A5)	SF 717-1
40 x 220 x 270 (DIN A4)	SF 717-2

**Konsole**  
Shelf



155 x 300

T x B (mm)	Art.-Nr.:
155 x 300	SF 718

**Schaukasten**  
Display



150 x 300 x 35  
150 x 150 x 35

T x B x H (mm)	Art.-Nr.:
150 x 300 x 35	SF 741
150 x 150 x 35	SF 742

**Display**  
Display



30° vorgeneigt  
30° slant

T x B x H (mm)	Aufkantung / lip (mm)	Art.-Nr.:
310 x 220 x 60	100	SF 745

**Buchhalter**  
Angled Book Holder



vorgeneigt  
slant

T x B x H (mm)	Aufkantung / lip (mm)	Art.-Nr.:
155 x 100 x 100	15	SF 746

**Präsentier**  
Display



255 x 305 x 150

T x B x H (mm)	Art.-Nr.:
255 x 305 x 150	SF 758

**Universalmulde**  
Multi-purpose Display



88 x 220 x 130

T x B x H (mm)	Aufkantung / lip (mm)	Art.-Nr.:
88 x 220 x 130	80	SF 759

**Alu- Kantenschutz**  
Alu Edge Cover 



Abschlussleiste,  
20 x 22,8 x 5,3 mm

L (mm)	Ausführung / Style	Art.-Nr.:
2500	blank/raw	KP 302
3000	blank/raw	KP 302-0
2500	eloxiert E 6 EV1 / anodized E 6 EV1	KP 302-1
3000	eloxiert E 6 EV1 / anodized E 6 EV1	KP 302-2

**Alu- Abdeckprofil**  
Alu Edge Cover 



40 x 6 x 1,3 mm



L (mm)	Ausführung / Style	Art.-Nr.:
2500	blank/raw	KP 320
3000	blank/raw	KP 320-0
2500	eloxiert E 6 EV1 / anodized E 6 EV1	KP 320-1
3000	eloxiert E 6 EV1 / anodized E 6 EV1	KP 320-2

**Bit mit Abstandhalter**  
Distance guide socket Bit



für KP 330-1  
for KP 330-1

Art.-Nr.:  
KP 332

**Gummiringe**  
Plastic Ring  

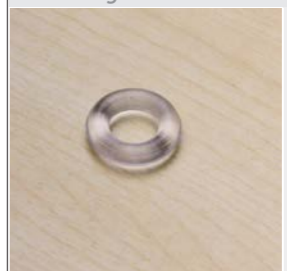

klar, für Glasbodenträger TW 424  
clear, for glass shelf bracket TW 424

Art.-Nr.:  
KP 316

**Alu - Stoskantenverbinder**  
Alu Buttjoint Connection 



zum Verbinden von  
Stoßkanten, 18 x 7 x 0,85 mm

L (mm)	Ausführung / Style	Art.-Nr.:
2500	blank/raw	KP 303
3000	blank/raw	KP 303-0
2500	eloxiert E 6 EV1 / anodized E 6 EV1	KP 303-1
3000	eloxiert E 6 EV1 / anodized E 6 EV1	KP 303-2

**Alu - Eckverbinder**  
Alu Corner Connection 



zum Verbinden von  
90°-Ecken, 47,5 x 47,5 mm

L (mm)	Ausführung / Style	Art.-Nr.:
2500	blank/raw	KP 301
3000	blank/raw	KP 301-0
2500	eloxiert E 6 EV1 / anodized E 6 EV1	KP 301-1
3000	eloxiert E 6 EV1 / anodized E 6 EV1	KP 301-2

**Glassauger**  
Glass-Buffer



verwendbar für Artikel:  
for use in combination with:  
TW 430, TW 443, TW 444,  
TW 4443, TW 472, TW 543

Ø (mm)	Art.-Nr.:
15	KP 315-1
10	KP 315-2

**Elastikpuffer**  
Elastic Buffer



selbstklebend, glasklar  
ideal als Kratzschutz und  
Abstandhalter  
self adhesive, clear

H (mm)	Ø (mm)	Art.-Nr.:
2,2	7,9	KP 308-1
3,5	12,7	KP 308-2
5,0	11,1	KP 308-3

**Alu - Abschlussprofil**  
Alu Edge Cover 



47,5 x 22 mm

L (mm)	Ausführung / Style	Art.-Nr.:
2500	blank/raw	KP 314
3000	blank/raw	KP 314-0
2500	eloxiert E 6 EV1 / anodized E 6 EV1	KP 314-1
3000	eloxiert E 6 EV1 / anodized E 6 EV1	KP 314-2

Lackierte oder pulverbeschichtete Profile in jeder Sonderfarbe (z.B. gemäß RAL) auf Wunsch erhältlich.  
Coated or powder-coated profiles in any custom color (e.g. according to RAL) available on request.

**Alu- Einhängprofil waagrecht**  
Alu Split Batten horizontal 



für die Wandmontage  
von Paneelen, paarweise,  
Höhe 28 mm  
for wall mounting of panels,  
by pairs, height 28 mm

L (mm)	Art.-Nr.:
2400	KP 305

**Montage-Profil senkrecht**  
Vertical Mounting Profile 



Zur einfachen, schnellen und exakten Montage von Lamellenwänden. (Passgenaue CNC-Bohrungen für die Schrauben werden von Spacewall vorgefertigt.)

L (mm)	Art.-Nr.:
2439	KP 330-1

**Bohrschablone**  
Drill Stencil



Montagehilfe für die Durchgangsbohrungen in den Aluprofilen  
Nur für SPACEWALL® light  
Mounting guide for through-hole drilling of alu-profiles.  
For SPACEWALL® light only.

Art.-Nr.:  
KP 310

**Führungshilfen**  
Guide Discs 



für KP 330-1, zum passgenauen Einhängen der Lamellenwände, 6 Stück  
for use with KP 330-1, for precise suspension of slat walls, 6 pieces

Ø (mm)	Art.-Nr.:
27	KP 331



### Steckbuchse

Socket

bestehend aus: 1 Buchse (konkav) <sup>1)</sup> 35 x 35 mm,  
1 Sechskantmutter <sup>2)</sup>,  
1 Unterlegscheibe <sup>3)</sup>

set consisting of:  
1 Socket (konkav) <sup>1)</sup> 35 x 35 mm  
1 Hexagon nut <sup>2)</sup>,  
1 Grommet <sup>3)</sup>

Bohrung Buchse 16mm (für 19 mm Platten geeignet)  
Drilling of Socket 16 mm (available for 19 mm walls)

Passende Kunststoffringe für Glas <sup>4)</sup> (Glasbohrung 22 mm Durchmesser)  
müssen separat bestellt werden.

Valid rubber rings for glass (Drilling diameter 22 mm) are not included  
in the set and have to be ordered seperately.

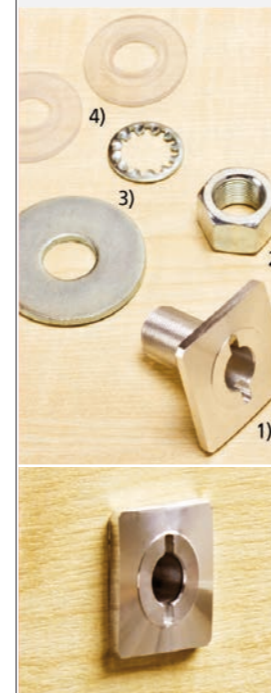

Ausführung	Art.-Nr.:
Alu-blank alu-blank	LM 600-1
Alu-mattverchromt Alu-dull chromed	LM 600-2
Alu-mattvernickelt Alu-dull nickeled	LM 600-3
Kunststoffringe rubber rings	LM 600-5

### Dübelbuchse

Screw Anchor Socket

bestehend aus: 1 Dübelbuchse, 35 x 35 x 95 mm,  
1 Dübel (S20),

set consisting of:  
1 Screw Anchor Socket 35 x 35 x  
95 mm  
1 Screw Anchor,

Zum Einbau in Ziegel- oder Betonmauerwerk  
For installation into brick or concrete masonry

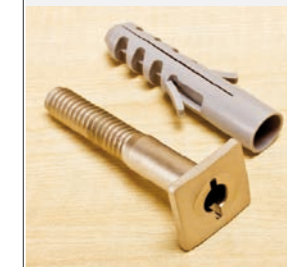

Ausführung	Art.-Nr.:
Alu-blank alu-blank	LM 620-1
mattverchromt dull chromed	LM 620-2
mattvernickelt dull nickeled	LM 620-3

### Glasplattenhalter

Glass Shelf Bracket

28  
mm

für 8 mm Glasplatten, paarweise zu verwenden,  
Tragkraft 8 kg

for 8 mm glass plates, to be used in pairs, load capacity 8 kg

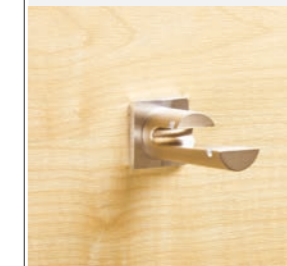

Ausführung	Art.-Nr.:
Alu-blank alu-blank	LM 609-1
Alu-mattverchromt Alu-dull chromed	LM 609-2
Alu-mattvernickelt Alu-dull nickeled	LM 609-3

### Schraubbuchse

Screw Socket

für nachträglichen Einbau in Holzplattenwerkstoffe  
ab 19 mm Dicke, Bohrung Ø 15 mm, 35 x 35 x 47 mm

for subsequent installation in wood panel materials  
from 19 mm thickness, drilling Ø 15 mm, 35 x 35 x 47 mm

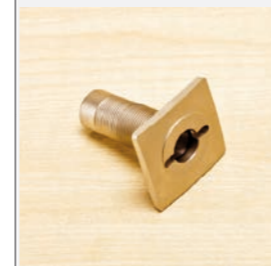

Ausführung	Art.-Nr.:
Alu-blank alu-blank	LM 621-1
mattverchromt dull chromed	LM 621-2
mattvernickelt dull nickeled	LM 621-3

### Montageschlüssel

Ball holder



Zur Montage von  
Dübelbuchsen und Schraubbuchsen  
For mounting of screw anchor sockets  
and srew sockets

Art.-Nr.:

LM 624

**Abhängearm**  
Straight Arm



gerade, mit Scheibe Ø 25 mm,  
Tragkraft 18 kg

straight, with disc Ø 25 mm,  
load capacity 18 kg

B (mm)	Ausführung	Art.-Nr.:
160	Edelstahl stainless steel	LM 602-1
250	Edelstahl stainless steel	LM 602-2
160	mattverchromt dull chromed	LM 602-3
250	mattverchromt dull chromed	LM 602-4

**Abhängearm**  
Straight Arm



gerade, mit Stift Ø 6 mm,  
Tragkraft 18 kg

straight, with disc Ø 25 mm,  
load capacity 18 kg

B (mm)	Ausführung	Art.-Nr.:
250	Edelstahl stainless steel	LM 603-1
250	mattverchromt dull chromed	LM 603-2

**Abhängearm**  
Straight Arm



Neigung ca. 25°, mit Kugeln  
Tragkraft 18 kg

Slope approx. 25°, with balls,  
load capacity 18 kg

B (mm)	Ausführung	Art.-Nr.:
380	Edelstahl stainless steel	LM 606-1
380	mattverchromt dull chromed	LM 606-2

**Abhängearm**  
Straight Arm



gebogen, ca 25°, mit Kugeln  
Tragkraft 18 kg

Slope approx. 25°, with balls,  
load capacity 18 kg

Ausführung	Art.-Nr.:
Edelstahl stainless steel	LM 625-1
mattverchromt dull chromed	LM 625-2

**Glasplattenhalter**  
Wood Shelf Bracket



mit Gummiringen,  
with rubber bands

Tragkraft bei einer Länge von:  
load capacity with a length of:

260 mm - 18 kg  
310 mm - 17 kg  
360 mm - 14 kg

B (mm)	Ausführung	Art.-Nr.:
260	Edelstahl stainless steel	LM 604-1
310	Edelstahl stainless steel	LM 604-2
360	Edelstahl stainless steel	LM 604-3
260	mattverchromt dull chromed	LM 604-4
310	mattverchromt dull chromed	LM 604-5
360	mattverchromt dull chromed	LM 604-6

**Holzbodenträger**  
Wood Shelf Bracket



mit Bohrungen Ø 4,5 mm,  
with drilling holes Ø 4,5 mm

Tragkraft bei einer Länge von:  
load capacity with a length of:

260 mm - 18 kg  
310 mm - 17 kg  
360 mm - 14 kg

B (mm)	Ausführung	Art.-Nr.:
260	Edelstahl stainless steel	LM 605-1
310	Edelstahl stainless steel	LM 605-2
360	Edelstahl stainless steel	LM 605-3
260	mattverchromt dull chromed	LM 605-4
310	mattverchromt dull chromed	LM 605-5
360	mattverchromt dull chromed	LM 605-6

**Konsole**  
Console



Blech, Farbe RAL 6006  
(Halter in mattchrom), gerade

Blank sheet, colour: RAL 6006,  
holder dull chromed, straight

B x T (mm)	Art.-Nr.:
300 x 115	LM 636-1

**Ballhalter**  
Ball Holder



Ring innen Ø150 mm,  
für Ballgrößen Ø 160 - 340 mm

Inner diameter Ø150 mm,  
For ball sizes from Ø 160 - 340 mm

Art.-Nr.:
LM 612-0

**Glasplattenhalter mit Gewindebohrung M8**  
Wood Shelf Bracket with tapped hole M8



mit Gummiringen,  
zur Verwendung mit Tragegestange LM 610-1 bis 610-6  
with rubber bands, for use with sloping arm LM 610-1 to 610-6

Tragkraft bei einer Länge von:  
load capacity with a length of:

260 mm - 18 kg  
310 mm - 17 kg  
360 mm - 14 kg

B (mm)	Ausführung	Art.-Nr.:
260	Edelstahl stainless steel	LM 604-11
310	Edelstahl stainless steel	LM 604-12
360	Edelstahl stainless steel	LM 604-13
260	mattverchromt dull chromed	LM 604-14
310	mattverchromt dull chromed	LM 604-15
360	mattverchromt dull chromed	LM 604-16

**Holzbodenträger mit Gewindebohrung M8**  
Wood Shelf Bracket with tapped hole M8



mit Bohrungen Ø 4,5 mm,  
zur Verwendung mit Tragegestange LM 610-1 bis 610-6  
with drilling holes Ø 4,5 mm, for use with sloping arm LM 610-1 to 610-6

Tragkraft bei einer Länge von:  
load capacity with a length of:

260 mm - 18 kg  
310 mm - 17 kg  
360 mm - 14 kg

B (mm)	Ausführung	Art.-Nr.:
260	Edelstahl stainless steel	LM 605-11
310	Edelstahl stainless steel	LM 605-12
360	Edelstahl stainless steel	LM 605-13
260	mattverchromt dull chromed	LM 605-14
310	mattverchromt dull chromed	LM 605-15
360	mattverchromt dull chromed	LM 605-16

**Tragegestange**  
Bar

bestehend aus : 1 Tragegestange <sup>1)</sup>, 2 Ringhalter zur Befestigung an <sup>2)</sup> Glas- oder Holzbodenträgern <sup>3)</sup>, LM 604-11 bis 16 oder LM 605-11 bis 16 müssen separat bestellt werden (Gewindebohrung erfolgt ohne Aufpreis). Tragkraft 32 kg

consisting of : 1 bar <sup>1)</sup>, 2 ring holders for fixing at <sup>2)</sup> glass-/wood shelf brackets <sup>3)</sup>, LM 604-11 to 16 or LM 605-11 to 16 have to be ordered separately.  
(Drilling is without surcharge). load capacity: 32 kg



B (mm)	Ausführung	Art.-Nr.:
625	Edelstahl stainless steel	LM 610-1
1000	Edelstahl stainless steel	LM 610-2
1250	Edelstahl stainless steel	LM 610-3
625	mattverchromt dull chromed	LM 610-4
1000	mattverchromt dull chromed	LM 610-5
1250	mattverchromt dull chromed	LM 610-6

## Ministyle Ministyle

MINISTYLE



### Steckbuchse „Mini“ Socket

zum Einkleben mit Bund (Bohrung Buchse Ø 12 mm)  
Länge 21 mm  
for flush mounting (drilling of socket Ø 12 mm)  
length: 21 mm



Ausführung	Art.-Nr.:
Alu-blank alu-blank	LM 671-1
mattverchromt dull chromed	LM 671-2
mattvernickelt dull nickerled	LM 671-3

### Steckbuchse „Mini“ Socket

bestehend aus:  
1 Buchse 22 x 22 mm,  
1 Flachmutter  
(Bohrung Buchse Ø 12 mm)  
passende Kunststoffringe für Glas  
(müssen separat bestellt werden)

consisting of:  
1 socket 22 x 22 mm,  
1 thin nut  
(drilling of socket Ø 12 mm)  
suitable plastic rings  
(to be ordered seperately)



Ausführung	Art.-Nr.:
Alu-blank alu-blank	LM 670-1
mattverchromt dull chromed	LM 670-2
mattvernickelt dull nickerled	LM 670-3
Kunststoffringe für Glasbohrung Ø 14 mm Plastic rings für glass drilling Ø 14 mm	LM 670-5

### Dübelbuchse „Mini“ Screw Anchor Socket

bestehend aus:  
1 Dübelbuchse 22 x 22 x 70 mm,  
1 Dübel (S14)  
Zum Einbau in Ziegel- oder Betonmauerwerk  
For installation into brick or concrete masonry

consisting of:  
1 socket 22 x 22 x 70 mm,  
1 screw anchor (S14)



Ausführung	Art.-Nr.:
Alu-blank alu-blank	LM 673-1
mattverchromt dull chromed	LM 673-2
mattvernickelt dull nickerled	LM 673-3

### Steckbuchse „Mini“ Socket

zum Einkleben (bündig)  
for flush mounting



Art.-Nr.:
LM 672

### Abhängearm straight Arm



mit Aufkantung, ca 20°,  
with upturn, approx. 20°  
Tragkraft ca. 3,5 kg / \*2,5 kg  
load capacity approx. 3,5 kg / \*2,5 kg

B (mm)	Ausführung	Art.-Nr.:
100	Edelstahl stainless steel	LM 679-1
200	Edelstahl stainless steel	LM 679-2
300*	Edelstahl stainless steel	LM 679-3
100	mattverchromt dull chromed	LM 679-4
200	mattverchromt dull chromed	LM 679-5
300*	mattverchromt dull chromed	LM 679-6

### Abhängearm straight Arm



gerade, mit Stift,  
straight, with pin  
Tragkraft ca. 3,5 kg / \*2,5 kg  
load capacity approx. 3,5 kg / \*2,5 kg

B (mm)	Ausführung	Art.-Nr.:
100	Edelstahl stainless steel	LM 676-1
200	Edelstahl stainless steel	LM 676-2
300*	Edelstahl stainless steel	LM 676-3
100	mattverchromt dull chromed	LM 676-4
200	mattverchromt dull chromed	LM 676-5
300*	mattverchromt dull chromed	LM 676-6

### Tragarm Bracket



für Glas-/Holzböden  
for glass/wood shelf brackets  
Tragkraft ca. 3,5 kg / \*2,5 kg  
load capacity approx. 3,5 kg / \*2,5 kg

B (mm)	Ausführung	Art.-Nr.:
150	Edelstahl stainless steel	LM 677-1
250*	Edelstahl stainless steel	LM 677-2
150	mattverchromt dull chromed	LM 677-3
250*	mattverchromt dull chromed	LM 677-4

### Schräghänger Arm



mit 7 Stiften  
with 7 pins  
Tragkraft ca. 2,5 kg  
load capacity approx. 2,5 kg

B (mm)	Ausführung	Art.-Nr.:
290	Edelstahl stainless steel	LM 678-1
290	mattverchromt dull chromed	LM 678-2

**Microstyle**  
Microstyle

MICROSTYLE

**Einpressbuchse „Micro“**  
Socket



zum Einkleben, mattvernickelt, Länge 21 mm, für Platten ab 19 mm Stärke, Tragkraft ca. 4 kg  
for flush mounting, dull-nickel, length: 21 mm, for walls from 19 mm thickness, load capacity: 4 kg

Art.-Nr.:  
**LM 660-1**

**Glas-/Holzbodenträger**  
Glass / Wood Shelf Bracket



mit Bohrung zur Befestigung von Holzböden, mit Gummiringen, Tragkraft ca. 4 kg  
with drilling for fixing of wood shelf brackets, with rubber rings, load capacity approx. : 4 kg

L (mm) Art.-Nr.:  
200 **LM 661-1**

**Einzel-Glaspräsentter**  
Single Glass Socket



für Glasböden Stärke 6-8 mm Größe ca. 125 x 300 mm mattvernickelt, Tragkraft ca. 2,5 kg  
for glass brackets, thickness from 6-8 mm, size: 125 x 300 mm, load capacity approx. : 2,5 kg

Art.-Nr.:  
**LM 663-0**



 

**Konfektionsstange**  
Bar



für Buchsenabstand 625 mm, Tiefe 200 mm, Tragkraft ca. 8 kg  
for socket diameter of 625 mm, depth 200 mm, load capacity approx. : 8 kg

L (mm) Art.-Nr.:  
750 **LM 662-0**



 

**T-Arm**  
T Bar



gerade, mit Stiften, Tragkraft ca. 3,5 kg  
straight, with pins, load capacity approx.: 3,5 kg

L x B (mm) Art.-Nr.:  
200 x 350 **LM 662-5**



 

**Abhängearm**  
Straight Arm



gerade, mit Stift, Tragkraft ca. 4 kg  
straight, with pin, load capacity: 4 kg

L (mm) Art.-Nr.:  
100 **LM 660-5**  
160 **LM 660-6**  
200 **LM 660-7**  
260 **LM 660-8**  
310 **LM 660-9**

 

**Brillenpräsentter (Set)**  
Eyeglass Holder



inkl. Alu-Einpressbuchse Ø 9,5 mm, Bohrung Ø 8 mm, für Platten ab 13 mm Stärke, Lochtiefe 14,5 mm. **ACHTUNG: Brillenhalter nicht mit MICROSTYLE-Buchse einsetzbar!**  
including alu socket Ø 9,5 mm, drilling Ø 8 mm, for walls of 13 mm thickness, borehole 14,5 mm. Attention! Eyeglass holder is not compatible to **MICROSTYLE** socket.

Art.-Nr.:  
**LM 650**

Index nach Artikelnummern / Index by Item Numbers

Art.-Nr.	Seite / Page	Art.-Nr.	Seite / Page	Art.-Nr.	Seite / Page
<b>Sonderprogramm / Special Accessories</b>					
G 101, G 102, G 103, G 104, G 105	24	PF 198	30	TW 453	13
G 106, G 107, G 108, G 109, G 110	24	PF 199	30	TW 454-0, TW 454-1, TW 454-2	11
G 111, G 112, G 113, G 122	24	PF 200	30	TW 455	16
<b>Warenträger MF / Accessories MF</b>					
MF 265-1, MF 265-2, MF 265-7, MF 265-8	8	<b>Metal-Warenträger TW / Metal Access. TW</b>			
MF 265-3, MF 265-4, MF 265-9, MF 265-10	8	TW 400-1, TW 400-2, TW 400-3, TW 400-4, TW 400-5	11	TW 455-2	17
MF 265-11, MF 265-12, MF 265-13, MF 265-14	8	TW 401-1, TW 401-2, TW 401-3, TW 401-4, TW 401-5, TW 401-6, TW 401-7, TW 401-8	10	TW 456-1, TW 456-2	13
MF 265-15, MF 265-16	8	TW 402-1, TW 402-2, TW 402-3	14	TW 458, TW 459	17
MF 278	8	TW 403	14	TW 460-1, TW 460-2	17
MF 2.80-1, MF 2.80-2, MF 2.81, MF 2.82, MF 2.83	9	TW 404	12	TW 461-1, TW 461-2	17
<b>Warenträger PF /</b>					
<b>Plastics Accessories PF</b>					
PF 101-0, PF 101-1, PF 101-2, PF 101-4, PF 101-5, PF 101-6	26	TW 405	12	TW 462-1, TW 462-2	17
PF 102, PF 103	26	TW 406	12	TW 463	13
PF 105	26	TW 407	15	TW 464	10
PF 106, PF 107	26	TW 407-1, TW 407-2, TW 407-3, TW 407-6, TW 407-7, TW 407-8, TW 408	15	TW 465	17
PF 110, PF 111	26	TW 409-0, TW 409-1, TW 409-2, TW 409-3, TW 409-4	14	TW 469-1, TW 469-2	13
PF 112-1	26	TW 410-1, TW 410-2, TW 410-3, TW 410-4, TW 410-5	10	TW 470	13
PF 113-1, PF 113-2, PF 113-3	26	TW 411-1, TW 411-2, TW 411-3, TW 411-4, TW 411-5, TW 411-6	10	TW 471	17
PF 114-1, PF 114-2	26	TW 412	15	TW 472-0, TW 472-1, TW 472-2, TW 472-3, TW 472-4, TW 472-5	14
PF 114-3, PF 114-4	26	TW 413	15	TW 473-0, TW 473-1, TW 473-2, TW 473-3, TW 473-4	10
PF 115	26	TW 414-2, TW 414-3, TW 414-4, TW 414-5	10	TW 474	15
PF 117-0, PF 117-1	27	TW 415-1, TW 415-2	18	TW 477-2, TW 477-3, TW 477-4, TW 477-5	10
PF 117-2, PF 117-3	27	TW 416	15	TW 478-2, TW 478-3, TW 478-4	11
PF 118	27	TW 417	15	TW 479-1, TW 479-2, TW 479-3, TW 479-4, TW 479-5	10
PF 120-1	27	TW 418	15	TW 480	17
PF 121-0, PF 121-1, PF 121-2, PF 121-4, PF 121-5	27	TW 4175-1, TW 4175-2, TW 4175-3, TW 4175-4	11	TW 481-1, TW 481-2	13
PF 122	27	TW 422	16	TW 482	17
PF 124	27	TW 423	16	TW 483	13
PF 141	27	TW 424-0, TW 424-1, TW 424-2, TW 424-3, TW 424-4	14	TW 484	17
PF 142	27	TW 425	16	<b>Kunststoff-Warentr. TW / Plastics Access. TW</b>	
PF 145	28	TW 426	16	TW 165-1	31
PF 146	28	TW 427	16	TW 191-L, TW 191-R	31
PF 149	28	TW 428	16	TW 476-1, TW 476-2, TW 476-3	11
PF 155	28	TW 430-3, TW 430-4, TW 430-5	14	TW 476-5	11
PF 157	28	TW 438	16	TW 485-1, TW 485-2	30
PF 158	28	TW 439	16	TW 486	30
PF 159	28	TW 441-1	12	TW 487	30
PF 161-1, PF 161-2, PF 161-3, PF 161-4	28	TW 442	12	TW 488, TW 488-1	30
PF 162-1, PF 162-2, PF 162-3, PF 162-4	28	TW 443-0, TW 443, TW 443-1	14	TW 489-1	30
PF 165-1	28	TW 443-5	14	TW 489-3	30
PF 166	28	TW 444	14	TW 489-2	31
PF 167	29	TW 4443-0, TW 4443-1, TW 4443-2, TW 4443-3	14	TW 491	31
PF 168-1, PF 168-2	29	TW 445	12	TW 493	31
PF 176-2, PF 176-3	29	TW 447	12	TW 494	31
PF 181-1	29	TW 448-1, TW 448-2	12	TW 495	31
PF 181-2	29	TW 449, TW 449-2, TW 449-3	16	TW 496	31
PF 184	29	TW 450, TW 450-1	12	TW 497-1, TW 497-2	31
PF 185	29	TW 451-1, TW 451-2	12	TW 498-1, TW 498-2	31
PF 186	29	TW 452	13	TW 499-0, TW 499-1, TW 499-2, TW 499-3	11
PF 195	29	<b>Seidenmatt verchromt TW / Satin Chrome TW</b>			
PF 196	29	TW 500-1, TW 500-2, TW 500-3, TW 500-4,	20		
PF 197	30	TW 501-1, TW 501-2, TW 501-3, TW 501-4	20		
		TW 504	20		
		TW 506	20		
		TW 507-2	20		
		TW 543, TW 543-1	20		
		TW 548-2	20		

Index nach Artikelnummern / Index by Item Numbers

Art.-Nr.	Seite / Page	Art.-Nr.	Seite / Page	Art.-Nr.	Seite / Page
<b>Black Line / Black Line Accessories</b>					
TW 607-2 WS/WH	22	KP 310	36	LM 625-1, LM 625-2	43
TW 604	22	KP 314, KP 314-0, KP 314-1, KP 314-2	36	LM 636-1	43
TW 606		KP 315-1	37	<b>MICROSTYLE / Microstyle</b>	
TW 6100-1, TW 6100-2, TW 6100-3, TW 6100-4, TW 6100-5	22	KP 316	37	LM 650	49
TW 6101-1, TW 6101-2, TW 6101-3, TW 6101-4, TW 6101-5	22	KP 320, KP 320-0, KP 320-1, KP 320-2	36	LM 660-1	49
TW 650-1	22	KP 330-1		LM 660-5, LM 660-6, LM 660-7, LM 660-8, LM 660-9	49
TW 677-5	22	KP 331	36	LM 661-1	49
TW 643, TW 643-1	22	KP 332	37	LM 662-0	49
TW 648-2	22	<b>INTERLINK / Interlink</b>		LM 662-5	49
TW 651-1	22	IL 900-1, IL 900-2, IL 900-3		LM 663-0	49
TW 680-1, TW 680-2	18	IL 900-4	39	<b>MINISTYLE / Ministyle</b>	
<b>Warenträger SLIM / Slim Accessories</b>					
SF 714-1, SF 714-2	33	IL 901-1, IL 901-2, IL 901-3	39	LM 670-1, LM 670-2, LM 670-3,	
SF 715-1, SF 715-2, SF 715-3, SF 715-4	33	IL 901-4	39	LM 670-5	47
SF 716-1, SF 716-2, SF 716-3		IL 901-5, IL 901-6, IL 901-7		LM 671-1, LM 671-2, LM 671-3	47
SF 716-4, SF 716-5	33	IL 901-8	39	LM 672	47
SF 720-1, SF 720-2, SF 720-3	33	IL 901-9, IL 901-10, IL 901-11		LM 673-1, LM 673-2, LM 673-3	47
SF 721	33	IL 901-12	39	LM 676-1, LM 676-2, LM 676-3,	
SF 722-1, SF 722-2	33	IL 902-1	39	LM 676-4, LM 676-5, LM 676-6	47
SF 723	33	IL 903	39	LM 677-1, LM 677-2, LM 677-3	
SF 726	33	<b>PIVOT / Pivot</b>			
SF 730-1, SF 730-2	33	MI 501, MI 502, MI 503	31	LM 678-1, LM 678-2	47
SF 731	33	MI 504, MI 505, MI 506	31	LM 679-1, LM 679-2, LM 679-3,	
SF 732-1, SF 732-2, SF 732-3, SF 732-4	34	<b>MONOSTYLE / Monostyle</b>			
SF 733-1, SF 733-2, SF 733-3, SF 733-4	34	LM 600-1, LM 600-2, LM 600-3, LM 600-5	43	LM 679-4, LM 679-5, LM 679-6	47
SF 734-1, SF 734-2, SF 734-3, SF 734-4	34	LM 602-1, LM 602-2, LM 602-3			
SF 717-1, SF 717-2	34	LM 602-4	44		
SF 718	34	LM 603-1, LM 603-2	44		
SF 741, SF 742	34	LM 604-1, LM 604-2, LM 604-3, LM 604-4, LM 604-5, LM 604-6,	44		
SF 745	34	LM 604-11, LM 604-12, LM 604-13, LM 604-14, LM 604-15, LM 604-16	44		
SF 746	34	LM 605-1, LM 605-2, LM 605-3, LM 605-4, LM 605-5, LM 605-6	44		
SF 758	34	LM 605-11, LM 605-12, LM 605-13, LM 605-14, LM 605-15, LM 605-16	44		
SF 759	34	LM 606-1, LM 606-2	45		
<b>Profile &amp; Kleinteile / Profiles</b>					
KP 301, KP 301-0, KP 301-1, KP 301-2	36	LM 609-1, LM 609-2, LM 609-3	33		
KP 302, KP 302-0, KP 302-1, KP 302-2	36	LM 610-1, LM 610-2, LM 610-3, LM 610-4, LM 610-5, LM 610-6	45		
KP 303, KP 303-0, KP 303-1, KP 303-2	36	LM 612-0	45		
KP 305	36	LM 620-1, LM 620-2, LM 620-3	43		
KP 308-1, KP 308-2, KP 308-3	37	LM 621-1, LM 621-2, LM 621-3	43		
		LM 624	43		



ONLINE-SHOP

Bestellen Sie bequem online in unserem Onlineshop unter [www.spacewall-shop.com](http://www.spacewall-shop.com)  
Order directly at [www.spacewall-shop.com](http://www.spacewall-shop.com)

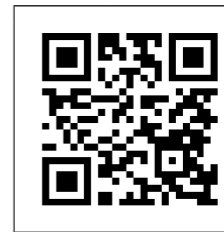

WEB

Weitere Informationen zu unseren Produkten unter [www.spacewall.de](http://www.spacewall.de)  
See [www.spacewall.de](http://www.spacewall.de) for further informations